

Safety Valves DN15



PUCO

Safety Valves DN15 1/2 x 3/4" K

Duco safety valves to protect closed heated and chilled water systems against excessive pressure.

Application

The safety valve has to be used in a closed heating or cooling system (**glycol max. 50%**).

Only use the Duco valve in a dry and frostfree location

Min / max. system temp.: -10°C / +120°C

Safety

Check whether the max. capacity and the opening pressure that are indicated on the valve match the values of the system.

All Duco safety valves meet the requirements of the Pressure Equipment Directive (PED)

"Directive 2014/68/EU Module B/Module D"

The quality system also complies with the **NEN-EN-ISO 9001**

NORM: **NEN-EN-ISO 4126-1**

Control knob - ABS (black)

Adjustment screw - PA 6 - 15% GF

Spring seat - PBT 420 1001

Spring cover - PA 6,6 - 30%GF

Valve disk - PA 6 - 30%GF

Preset spring - Spring steel (galvanised)

Membrane - EPDM Shore Peroxide cured

Valve body - Brass (CW617N) Pb<2,2%

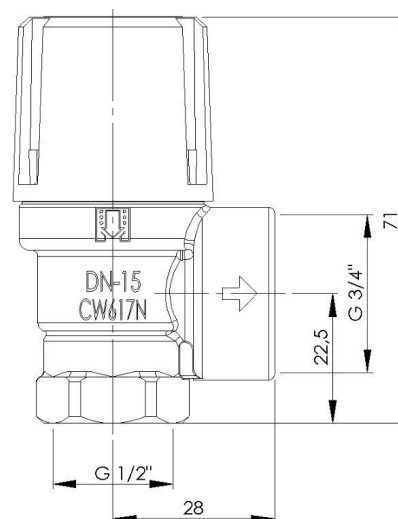
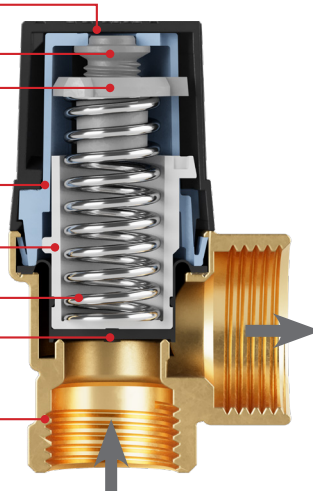

Safety Valves DN15

Article number	Set pressure bar	Heating capacity kW
1055-0-01-11	0,5	48
1055-0-02-11	1	64
1055-0-04-11	2	93
1055-0-05-11	2,5	107
1055-0-06-11	3	120
1055-0-08-11	4	148
1055-0-10-11	5	175
1056-0-06-11	6	200
1056-0-07-11	7	226
1056-0-08-11	8	252
1056-0-09-11	9	278
1056-0-10-11	10	302

PUCO

PenTec bv
Edisonweg 7
3442 AC Woerden
The Netherlands

Tel. +31 (0)182 503 100
E-mail info@pentecbv.nl
Internet www.duco.nl
www.pentecbv.nl